

ENVIRONMENTAL IMPROVEMENTS FOR RENOVATION WORK USING LASER SCRAPING

Kaori Nagai¹, Motoki Imazeki², Yasuaki Kaneko³, and Yuuki Kawai⁴

ABSTRACT

Construction sites in general are in environments where noise, vibration, and dust including. Especially in renovation and demolition works, concrete cutting, drilling, and scraping require not only loud noise, vibration, and dust, but also long hours of reaction force from the workers to use the machinery. Robotization has progressed in recent years and the environment for workers is improving, but the working environment in general sites where robots are difficult to install remains a challenge.

This study aims to develop a method to improve the noise and other working environments of refurbishment works. This paper describes the results of a feasibility study on a laser scraping method to reduce noise in the renovation of infrastructure facilities around residential suburban areas.

The results show that thin cement adhering to the rebar can be removed by the low power laser. Furthermore, a comparison of the noise level with conventional methods on site confirmed the superiority of laser scraping. This result indicates, in terms of lean construction, will reduce waste and improve the quality of the site.

KEYWORDS

Renovation, Environment, Sustainability, Concrete, Laser.

INTRODUCTION

Concrete structures built during the period of high economic growth are aging, and deterioration phenomena such as cracking, floating, and peeling are becoming apparent. There are various methods for repairing and renovating deteriorated concrete structures, and appropriate methods are selected according to the deterioration phenomena and surrounding environment. In the sectional repair method, one of the repair methods for concrete structures, the process starts with concrete removal, followed by reinforcement cleaning, corrosion protection, and sectional repair. It has been reported that the quality of the surface of the reinforcement after reinforcement cleaning affects the performance after repair (Kunieda 2010).

For example, in sectional repair work of concrete structures, concrete removal is performed using water jets or similar tools, and it is necessary to completely remove the mortar adhering to the reinforcement using tools such as jet chisels. At that time, it has been reported that incomplete removal can cause re-corrosion of the reinforcement (Watanabe et al. 2013).

In conventional reinforcement scraping, jet chisels and cup brushes are used to remove cement paste adhering to the reinforcement. Miyamoto (1973) reported that there is noise and

¹ Prof. Dr.Eng. Dept. of Architecture and Architectural Engineering, College of Industrial Technology, Nihon Univ., Japan, nagai.kaori@nihon-u.ac.jp

² ME Student, Dept. of Architecture and Architectural Engineering, College of Industrial Technology, Nihon Univ., Japan, cimo17030@g.nihon-u.ac.jp

³ Researcher, Technical Research Center, Tobishima Corporation, Japan, Yasuaki_Kaneko@tobishima.co.jp

⁴ Manager, Structural Engineering Office, Railway Operation Headquarters, West Japan Railway Company, Japan, yuuki-kawai@westjr.co.jp

vibration of 80 dB or more at 30 m from the work point in on-site concrete demolition work. In particular, sufficient consideration is required for elevated roads passing through residential areas in urban areas. Jet chisel work is essential due to the increasing number of infrastructure rehabilitation projects. This operation is one of the most difficult tasks to manage the process because of the limited working hours due to the loud noise. However, although some tools have been developed for scraping or chipping concrete, they have little effect on noise reduction. Therefore, we focused on laser technology as a new means of rebar cleaning that can reduce the burden on the work environment.

In recent years, laser technology has been considered for its applicability as a new surface treatment method for removing rust from metal material surfaces and has been implemented as laser cleaning work. Shirakawa et al. (2005) conducted an experiment to remove rust from iron towers using a 280W YAG laser. As a result, it was reported that laser cleaning improved adhesion of paint compared to cleaning with a metal brush. Hino et al (2018) reported that cleaning of metal materials is possible for various types of dirt by using a 3 kW YAG laser. In addition, Nishihara et al (2019) cleaning of molds is performed using a 70W fiber laser to remove dirt and oil from metal surfaces. Zhihu Zhou et al. (2023) have also explained the mechanism of laser cleaning and confirmed its effectiveness for cleaning metal and non-metal materials. Matsui (2003) reported the superiority of using lasers for graffiti removal on concrete. Although research on rust and paint film removal from metal substrates has been conducted in this way, no research has been conducted on the removal of cement materials adhering to steels.

In the philosophy of lean construction (Koskela 1997), this research is a development that will improve the quality of construction and the environment of on-site cleaning work. In this study, the research is aimed to develop a low-vibration, low-noise, low-dust, and reactionless method that can remove 1mm thick concrete scraping to reinforcing bars after the concrete is removing and red rust remaining after removal. The experiment is to use a portable laser of 200W and less for use at construction sites. This report describes the results of basic and applied experiments on the laser cleaning method using an understanding of the thermal effects of mortar, laboratory tests, and trial construction at actual sites.

MECHANISM OF LASER SCRAPING

The principle of laser scraping is shown in Figure 1. Laser scraping works by utilizing the ablation that occurs during laser irradiation. This involves instantaneously decomposing substances adhering to the surface layer of the irradiated area with laser light, and evaporating and sublimating them in the process while removing the target substance as long as it continues to absorb the energy of the laser in combination with the micro shock waves generated.

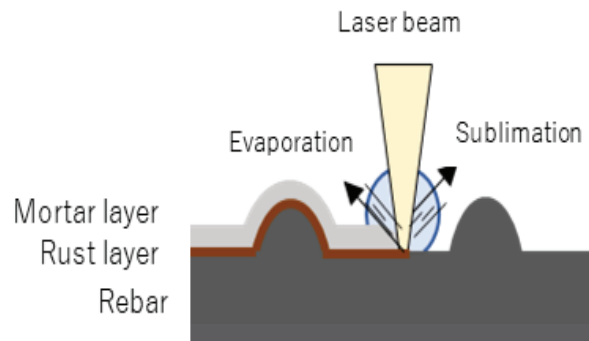

Figure 1: Laser scraping diagram

In this study, the test is tried with a low-power laser to remove 1 mm of cement without affecting the rebar. As shown in Figure 1, efficient irradiation can be achieved by using a galvanometer mirror to scan the laser light at high speed on substances adhering to the surface layer. At this

time, the laser energy density that causes ablation of the target material must always be higher than the energy density that causes ablation of the base material. This allows only the target material to undergo ablation without affecting the base material, making it possible to remove only the target substance.

LASER IRRADIATION EXPERIMENT

PURPOSE OF EXPERIMENT

This experiment verifies the removal performance using 100W lasers, based on the results of an experiment using mortar plates, to select laser irradiation conditions assuming a construction site.

CONDITION OF EXPERIMENT

The specimen is shown in Figure 2 and the irradiation range is shown in Figure 3. Assuming a structure such as a bridge, the specimen consisted of five D16 rebar's crossed at intervals of 130 mm and covered with 1 to 2.5 mm of mortar. The mortar adhered to the specimen was a premix TDR mortar (Hirama 2006) except for the vinylon fibers, and the external dimensions of the specimen were 950 x 950 mm. This mortar is repair materials for concrete structures.



Figure 2: The specimen

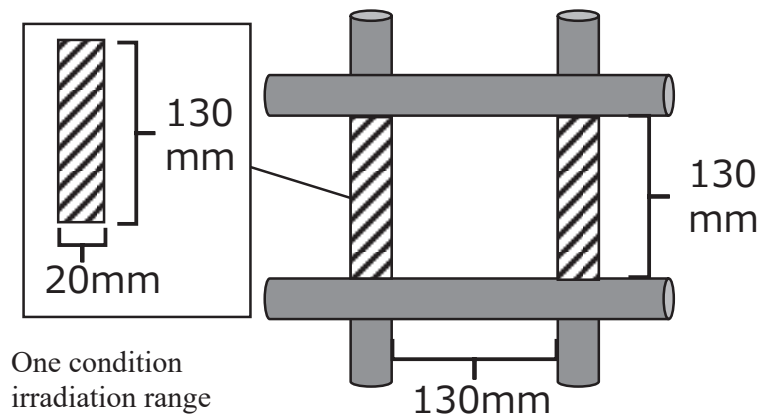

Figure 3: Laser Irradiation area

EXPERIMENTAL METHODS





Irradiation conditions are shown in Table 1 and scanning geometry in Table 2. Among the irradiation conditions, the frequency was selected from the preliminary experiments to have

high removal performance. In addition, the laser beam was scanned and irradiated to each shape to improve the removal efficiency. An irradiation schematic is shown in Figure 4.

Table 1: Laser Irradiation Condition

Power (W)	Mode	Frequency (kHz)	Irradiation Speed (mm/s)	Irradiation time (s)	Focus distance (mm)
100	パルス	70	0.3	180	163
			0.6		
			0.9		
			1.2		
			1.5		

Table 2: Scanning Geometry

				
Lissajous	Rectangle	Spiral-L	Spiral-S	Beeline

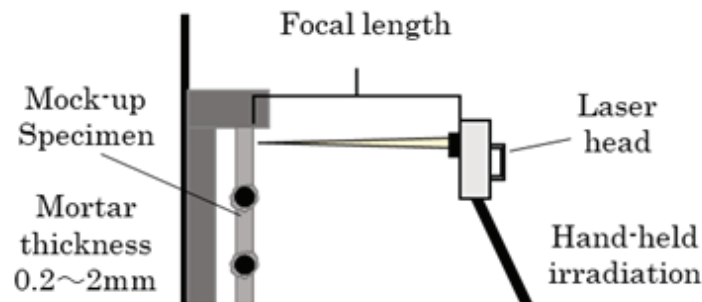

Figure 4: Laser irradiation schematic diagram

EVALUATION METHODS

Surface observation: Mortar and rust residues were visually checked after laser irradiation.

Removal rate: The removal rate was calculated from the images of the specimen after irradiation and after the use of a cup brush, using processing software to determine the evaluation area and the area of mortar removed.

Working time: The time required for the work was measured at two levels: the time required for laser irradiation alone, and the total time required for cup brush removal as a secondary process for the remaining areas. In the cup brush removal process, the completion of mortar and rust removal was visually determined.

RESULTS OF EXPERIMENT

The results of the removal performance under different laser irradiation conditions are shown in Figure 5. The graphs compare the results of the 100 W results of this experiment with data from the author's previous studies conducted using a 200 W fiber laser (Imazeki 2022). It was

found that the removal rate of the 100W laser was lower than that of the 200W laser under all conditions when using the laser alone. However, when a cup brush was used after irradiation with both the 100W and 200W lasers, almost the same level of removal rate was achieved. Considering that the mortar thickness of the mock-up created in this study ranged from 1mm to 2.5mm, it can be inferred that even 1mm thick mortar, which was the original target, could be removed using the laser alone, and thicker mortars could also be weakened by the heat generated by the laser. Furthermore, each laser machine used in this study had a different spot diameter, with the spot of the 100W laser being smaller. This factor may have contributed to the ability to weaken the mortar by achieving a similar power density as the 200W laser.

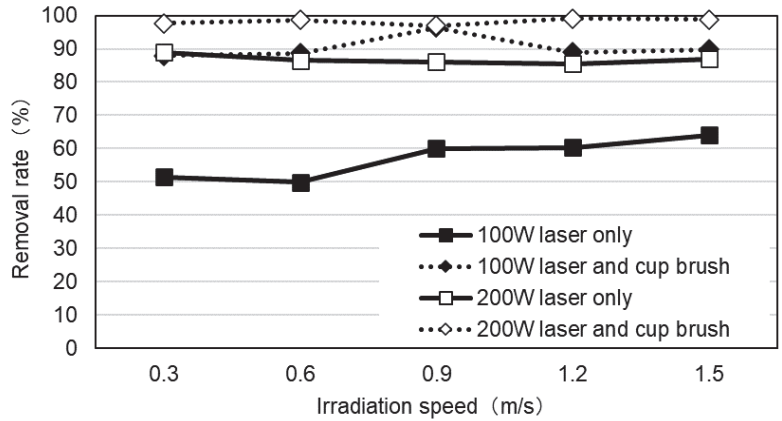

Figure 5: Comparison of removal performance

A comparison of scanning geometries is shown in Figure 6. In this experiment, a change in the removal rate after each operation was observed depending on the scanning geometry. The two types of spiral shapes tended to have higher removal rates, with the Spiral-S with a smaller diameter showing higher removal rates. The high removal rate of the spiral shape was also observed even when a cup brush was used, indicating that, among the scanning shapes, the spiral shape was more prone to heat accumulation in the center of the mortar because the laser beam was irradiated from the center towards the outside.

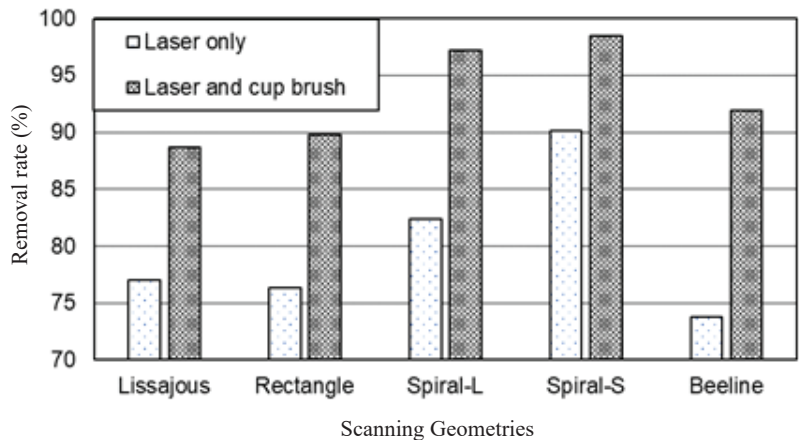

Figure 6: Comparison of scanning shapes

According to brittleness of the mortar. Furthermore, the maximum removal rate was 98.5% when the cup brush was used in combination with the laser beam, indicating the potential of laser scraping even with the 100 W laser, which is low power.

ON-SITE TESTS

TEST OVERVIEW

The field test construction location is shown in Figure 7. The construction site was the overhang of the slab on which the sectional repair was being constructed, in a space surrounded by a light-emitting soundproofing sheet. The concrete removal was completed and the rebar was exposed before the cleaning work was carried out. The rebar in question was $\phi 13$ round steel. For the test construction, one condition of laser irradiation was applied to one span (150 mm) of the assembled rebar.

The laser irradiation conditions were as follows: frequency 70 kHz, focal length 163 mm, irradiation speed 10 m/s, and two types of spirals with different irradiation diameters as the scanning shape. The irradiation time was not decided beforehand and was carried out at the discretion of the laser irradiation operator. As a comparison, a conventional cleaning method using a jet tool and a cup brush was also carried out. The end point of the cleaning work using the tools was determined at the operator's discretion.

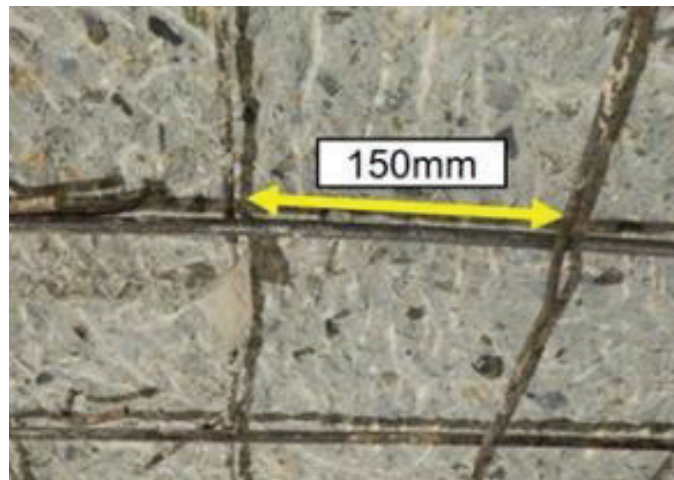

Figure 7: Irradiation area of on-site demonstration test

EVALUATION METHODS

The surface condition was checked when laser irradiation and cup brushes were used. The evaluation was based on the surface finish and compared with the conventional method.

The time required for laser irradiation and the time required to clean the surface using tools were measured using a stopwatch. Only the working time was measured and the comparison was made without including the time required for changing tools.

Measurements were taken using a digital dust meter (S) to measure the amount of dust prior to the cleaning work, during laser irradiation, jet chisels and cup brush application for 2 minutes. The average value of the measured dust amount was organized as a relative index with the dust amount before the installation set as 1.

Measurements were taken during each operation using an ordinary sound level meter (manufactured by Company R), and the measured values were expressed as equivalent noise level Leq (dB). Dust and noise were measured at a distance of 2 m from the workers.

RESULTS OF ON-SITE TESTS

Figure 8 shows the condition of the surface during the field test installation and Figure 9 shows the condition before and after scraping. As in the verification of the mock-up specimen, the laser irradiation was able to remove rust and thin mortar, but not all mortar could be removed

by laser irradiation alone. However, by using a cup brush to clean the surface after laser irradiation, it was possible to achieve a finish comparable to that of the conventional method (combination of jet chisels and cup brush).



Figure 8: On-site demonstration test situation

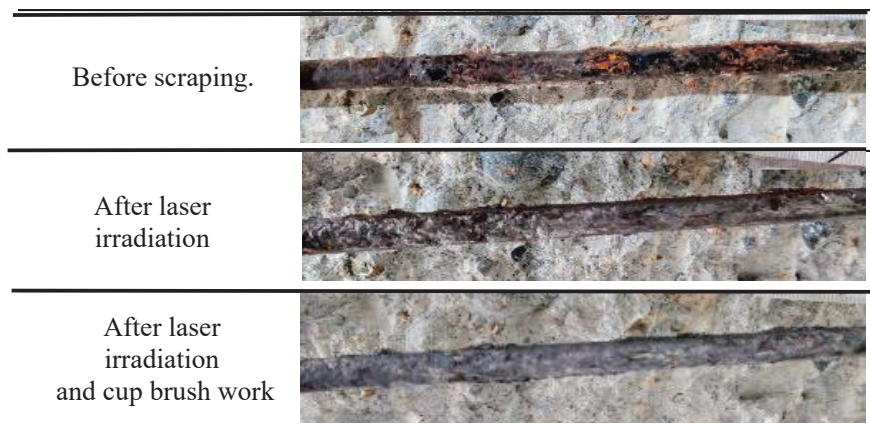

Figure 9: On-site rebar before and after scraping work

The working time per unit length is shown in Figure 10. The conditions in which laser irradiation was carried out increased the time required to clean the rebar compared to the conventional method. However, the time required for cup-brushing work was similar for all conditions.

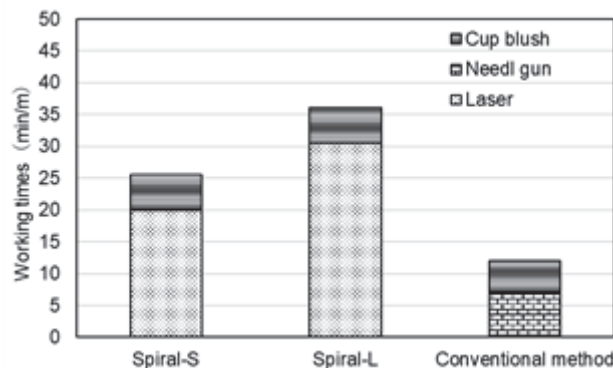

Figure 10: The results of Working times

The results of the dust measurements are shown in Figure 11. The objective of this experiment was to confirm the relative dust reduction effect. For this reason, the relative dust amount was organized as the dust amount before the construction (initial value) was set to 1.

It was confirmed that the amount of dust during laser irradiation was approximately 1/4 of that of a cup brush and 1/10 of that of a jet chisels, and that dust could be reduced significantly compared to the conventional method.

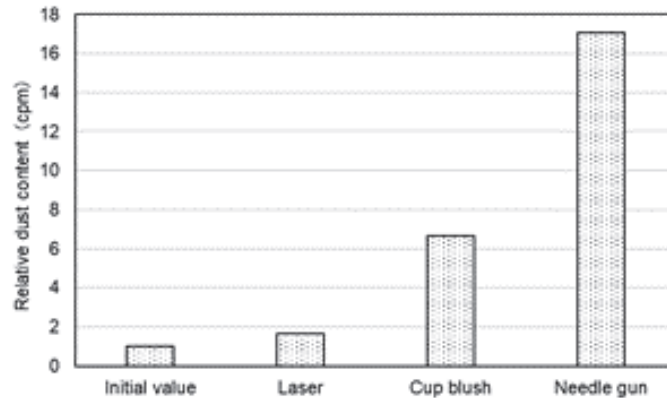

Figure 11: The results of dust measurement

The results of noise measurements are shown in Figure 12. The initial equivalent noise level during on-site work was 64.1 dB. The noise levels during each operation were 66.6 dB for laser irradiation, 92.6 dB for cup brush operation and 96.3 dB for jet tagger operation, and the equivalent noise levels for laser irradiation only were approximately 3/4 and 2/3 of those for cup brush and jet tagger respectively. The equivalent noise level during laser irradiation was similar to the initial value, confirming that laser scraping is less noisy than the conventional method.

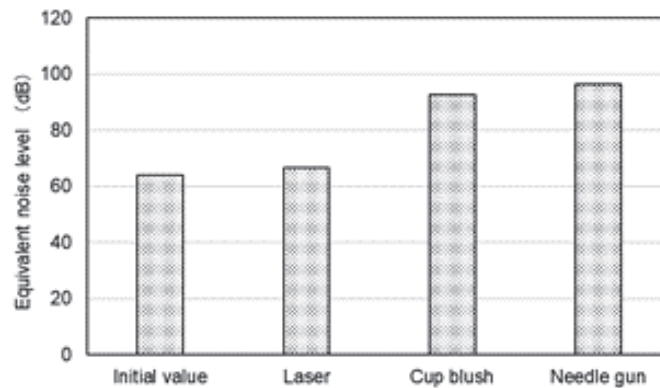

Figure 12: The results of noise measurement

DISCUSSION AND FUTURE ISSUES

KAIZEN OF SCRAPING WORK BY LASER

In this study, we confirmed that it was possible to use a 100W low-power laser on two types of materials: thin cement layers and rust (Figure 13). Previous studies have mostly focused on the removal of paint or rust from iron plates, where the materials were single and several hundred micrometers thick.

In laser processing of concrete, it has been reported that it vitrifies due to high temperature at 3kW or more (B. Tirumala Rao et al 2005). On the other hand, if the exposure time is short even at high power, the thermal influence on the material is small, and it has been reported that holes can be made in concrete (Nagai et al, 2018). In addition, the possibility of chipping the surface of concrete with about 500W has been reported (Kamata et al, 1996). From these results,

since the target of this study is a thin cement layer, it was thought that cement could be made brittle with low power and it was possible to demonstrate it.

This development can contribute to the improvement and quality enhancement of lean construction sites. The work time for digging in renovation projects can be long depending on the site conditions, or limited by noise problems. However, this development makes it possible to plan work hours. Furthermore, it is effective in reducing power consumption on site by making it smaller and simplifying its handling. Future research should be conducted to further reduce working hours.

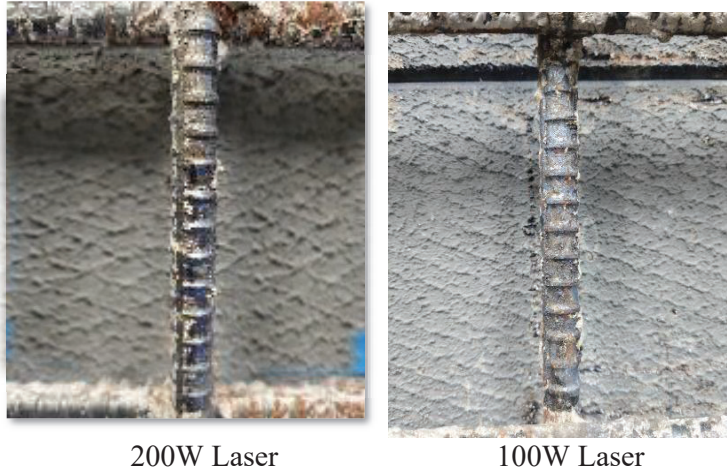

Figure 13: Compare of 200W Laser and 100W Laser

IMPROVEMENT OF WORK ENVIRONMENT

As a result of our examination of noise, vibration, and reaction force issues at construction sites, we have found that laser construction reduces noise problems and allows for renovation work to proceed in environments such as urban areas and near hospitals. Furthermore, the work environment for workers is clearly improved, and the use of non-reactive non-vibration scraping construction can contribute to reducing the burden on workers.

In the future, we believe that incorporating robots will lead to further improvements in the work situation.

REDUCTION OF GLOBAL ENVIRONMENTAL IMPACT

As a result of field tests, it was confirmed that the amount of dust generated is almost negligible. This is due to sublimation by laser. In mechanical processing such as water jetting and sandblasting, a large amount of water and sand is used, resulting in a large amount of dust and an increase in waste materials. These problems can be improved by using lasers.

In the future, further environmental improvements can be expected by suctioning the small amount of dust generated.

CONCLUSION

It was confirmed that mortar and red rust as thick as 1 mm could be removed even with a low level of laser irradiation of 100 W. Furthermore, for mortar thicker than 1 mm, the heat from the laser irradiation tended to weaken the mortar in a short time, reducing the cup brushing time. In the field, the combination of laser cleaning and cup brushing was found to provide removal performance comparable to conventional methods without the noise and vibration. This method was found to be effective in improving the environment for workers and excellent in areas where noise and dust control measures are difficult to implement.

ACKNOWLEDGMENTS

We are grateful to Akinobu Hirama, Yasuo Kawabata, Toshihiro Ito, Funao Kaneko (Tobishima Constriction Company), Ishibashi (PCL), Yamagata (Kokyo) for support.

The master students, Material Design and Construction Strategy at Nihon University for their contributions.

REFERENCES

- Kunieda Minoru. (2010). Trends and Future Prospects for Cross-Section Repair Methods, *concrete engineering*, 48(5), 92-96. doi.org/10.3151/coj.48.5_92
- Tadashi Watanabe, Yuji Matsubayashi, Tomio Hoshino & Toshiharu Kishi. (2013). A Studies on the Corrosion of Steel in Reinforced Concrete Members Repaired by Partial Restoration Method for Cross Section, *Journal of Japan Society of Civil Engineers*, 69(3), 281-294. https://www.jstage.jst.go.jp/article/jscejmcs/69/3/69_281/_pdf/-char/ja
- Shunji Miyamoto (1973). Noise and vibration associated with demolition work, *Concrete Journal*, 11(1), 49-59, _pdf (jst.go.jp)
- Kazuomi Shirakawa, Katsuaki Ohashi, Shuichi Ashidate, Kiyoshi Kurosawa, Michio Nakayama, Yutaka Uchida, Yuuji Nobusada, (2005). Development of Rust Stripping System Using High Power Laser, *The Institute of electrical engineers of Japan paper B*, 125(11), https://www.jstage.jst.go.jp/article/ieejpes/125/11/125_11_1084/_pdf/-char/ja
- Makoto Hino, Yoshiaki Hashimoto, Yutaka Mitooka, (2018), Laser Cleaning and Its Application, *Surface Technology*, 69(10),435-440, <https://doi.org/10.4139/sfj.69.435>
- Nishihara Keizo, Kanazawa Yusuke, Takashima Yasufumi. (2019). The Development of New Laser Cleaning Machine 「ELASER」, *Journal of Laser Processing Society*, 26(1), https://www.jstage.jst.go.jp/article/jlps/26/1/26_51/_pdf/-char/ja
- Zhihu Zhou, Weipeng Sun, Jiajun Wu, Hongwei Chen, Fei Zhang, and Shuangxi Wang, (2023) The Fundamental Mechanisms of Laser Cleaning Technology and Its Typical Applications in Industry, *Processes*, 11, 1445. <https://doi.org/10.3390/pr11051445>
- Isamu Matsui, Yukiyo Shinozaki, Kaori Nagai, Yuasa Noboru, (2004), Laser Irradiation Condition for The Removal of Graffiti from Concrete Surface : Removal method of graffiti from concrete surface by laser irradiation (Part 1), *Journal of Structural Engineering, Architectural Institute of Japan*, 69(585),57-62, https://doi.org/10.3130/aijs.69.57_3
- Lauri J. Koskela (1997), Lean production in construction, *Elsevier Science*, 47-57, https://www.researchgate.net/publication/267415622_Lean_production_in_construction
- Akinobu Hirama, Yasuo Kawabata, Masao Nagura, & Katsuya Matsuo. (2006). Development of Repair Splayed Mortar (TDR Shot Method) with Accelerating Agent, *Tobishima Technical Report*, 55,
- Motoki Imazeki, Yasuaki Kaneko, Yuki Kawai, Katsuhito Ishibashi, Ryo Sumimura, Kaori Nagai. (2022), Development of Concrete Scraping with a Laser, *Proceedings of the 31th Conference of Japan Society for Finishing Technology*,31, 147-150
- B. Tirumala Rao, Harish Kumar, & A.K. Nath. (2005). Processing of concretes with a high power CO2 laser. <https://doi.org/10.1016/j.optlastec.2004.05.001>
- Kaori Nagai, Stefan Beckemper, Reinhart Poprawe, Laser Drilling of Small Holes in Different Kinds of Concrete, *Civil Engineering Journal* 4(4), 766, 10.28991/cej-0309131
- Hirofumi Kamata, Takeo Mimori, Masaaki Tachiiwa, and Kenji Sugimoto. (1996). Study on Methods for Decontaminating Concrete Surface by Laser Treatment, *Laser research*, 24(2), 182-190, doi.org/10.2184/ljsj.24.182